CLASSIC STANDARD
CORDLOCK CONTROL SYSTEM



INSTALLATION INSTRUCTIONS

TOOLS REQUIRED

A few simple tools are required:

- Measuring tape and pencil
- Power drill, 3mm drill bit, and a 6mm hex driver.
- Flat blade and Phillips screwdriver
- Level [laser level recommended]

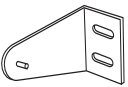
Additional fasteners other than those sent with your shade may be required depending on the mounting surface. Wallboard and plaster require the use of anchors such as expansion or toggle bolts. Brick, tile or stone need special plugs and drill bits. Remember to always pre-drill holes in wood to avoid splitting.

	Bugle Head or Dry Wall Screw only for Shallow Mount back holes.
	Hold down bracket [Optional].
	Hex head screw for any other hole.
	Extension bracket [optional]

Size [mm]	Brackets	Screws
Up to 1524	2	4
1524 - 2438	3	6
2438 - 3040	4	8

Arena Honeycomb shades are constructed to be hung as either an inside mount or an outside mount. The installation bracket can be mounted inside the window opening, for an inside mount, or on the moulding or wall above the window for an outside mount.

The extension bracket and the hold down bracket are optional items requested at the time of ordering the shade. The extension bracket provides projection of the installation bracket in order to clear obstructions.

The hold down bracket keeps the shade from swaying and is often used for installation on door windows.

ATTACHING THE BRACKETS

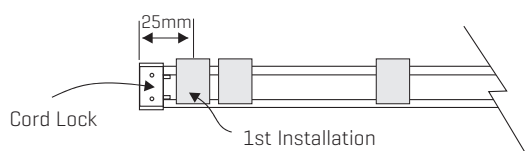

Larger shades may require additional brackets. Space additional brackets equally and align with the end brackets. Note placement of components inside headrail. Brackets must be placed in the open areas between components to avoid interfering with the operating mechanism. Mark these locations on top of window frame for inside mount or on wall for outside mount.

Inside Mount

Mount brackets to top or back of window frame, 24mm – 152mm in from edge of frame. Make sure brackets are aligned with one another.

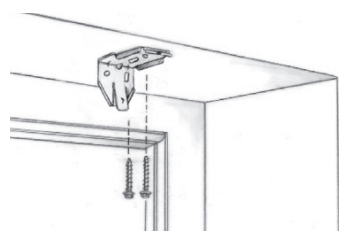

Outside Mount

Centre shade over window opening at desired height. Mark the position of the headrail ends on the wall. Attach mounting brackets to the wall, 25mm – 152mm in from the marks, making sure brackets are aligned with one another.

Mounting with Extension Brackets

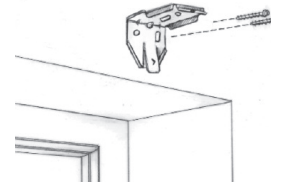
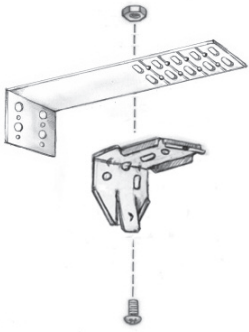

If you need to project the shade out from the mounting surface, use the supplied nuts and bolts to attach mounting brackets to the desired position in the extension bracket. With pliers, bend and break the unused part of the extension bracket. Attach extension brackets to mounting surface, making sure brackets are spaced as noted above.

Center shade in window opening. Insert the front clip of the bracket into the front groove of the rail. Push the rail back and up until the back clips of the bracket snap into the back groove of the rail.

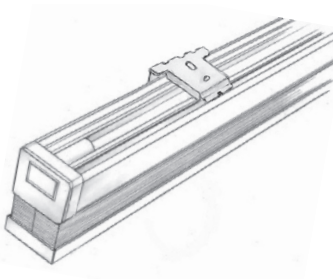

ATTACHING THE OPTIONAL BRACKETS

Optional Hold Down Brackets are mounted with the supplied screws. With the shade at its proper drop, place the pin of each Hold Down into the hole in each End Cap and mark the screw holes. Make sure the pins are level and aligned. Raise the shade, and then screw the Hold Down Bracket into the mounting surface.

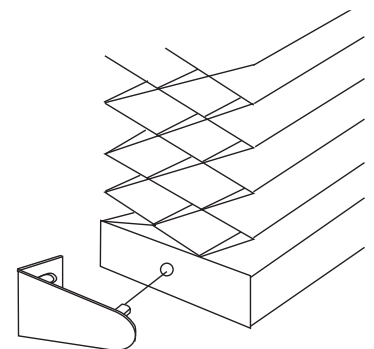

OPERATING YOUR SHADE

To lower or release shade, pull the cord inward toward the center of the shade.

To raise or lock shade, pull the cord straight down and outward toward the edge of the shade.

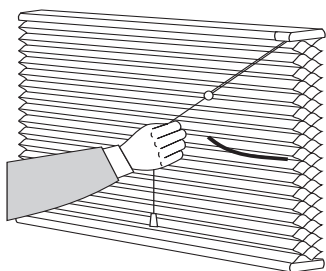

REMOVING YOUR SHADE

Using your fingers or a screwdriver, press tab on back of each bracket to release the shade.

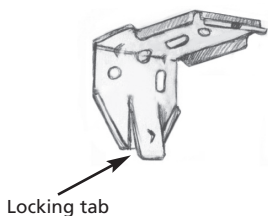

CARE AND CLEANING

ARENA Honeycomb Shades are made of anti-static, dust-resistant fabric which repels dirt and dust. For most honeycomb fabrics, the following cleaning options are available.

Dusting

- Regular light dusting with a feather duster is all the cleaning that is needed in most circumstances.

Vacuuming

- For deeper cleaning, vacuum gently with a brush attachment.

Compressed Air/Hair Dryer (Cool Setting)

- Use compressed air or a hair-dryer on a cool setting to blow dust and dirt off shades.

Spot-Cleaning

Caution: Do not spot-clean the following fabric ranges – Hendrix 20mm Blockout, and Harlem 10mm & 20mm Blockout

- Prepare a solution of warm water and a mild detergent.
- Dampen a clean cloth in the solution and wring it out.
- Dab the spot with the dampened cloth until it is gone. Do not rub the fabric.
- Allow the shade to dry in the completely lowered position.

Bathtub Cleaning/Water Immersion

Caution: Do not immerse the following fabric ranges – Essence Translucent, Hadley 20mm Blockout, Harlem 10mm & 20mm Blockout, and the Hendrix Fabric Range.

- Immerse the shade in a basin or bathtub filled with warm water and a mild detergent. Never immerse the headrail into the solution.
- Rinse with clean water.
- Before removing from the rinse water, fully raise the shade and tilt it to allow excess water to drain off.
- Dry the shade completely in the lowered position.

Ultrasonic Cleaning

Caution: Only the following fabric ranges can be ultrasonically cleaned – Essence Translucent, Clarity Sheer, and Harlem 10mm & 20mm Translucent.

- Some honeycomb fabrics can be ultrasonically cleaned by a professional.
- Specify that a mild detergent solution be used.
- Never immerse the headrail into the solution.
- Dry the shade completely in the lowered position.

Cleaning Table

The below table outlines the various cleaning methods for each fabric range.

Fabrics	Dusting	Vaccuming	Compress Air/Hair Dryer (cool)	Bathtub	Spot Cleaning	Ultrasonic Cleaning
Hadley 20mm Translucent	◆	◆	◆	◆	◆	
Hadley 20mm Blockout	◆	◆	◆		◆	
Hendrix 20mm Translucent	◆	◆	◆		◆	
Hendrix 20mm Blockout	◆	◆	◆			
Harlem 10mm Translucent	◆	◆	◆	◆	◆	◆
Harlem 20mm Translucent	◆	◆	◆	◆	◆	◆
Harlem 10mm Blockout	◆	◆	◆			
Harlem 20mm Blockout	◆	◆	◆			
Clarity 20mm Sheer	◆	◆	◆	◆	◆	◆
Essence Double Cell Translucent	◆	◆	◆		◆	◆

CHILD SAFETY

Protecting Your Children

Please be aware that blind cords or chains pose a strangulation hazard for children. To reduce the risk of strangulation, this internal window covering must be installed in such a way that a loose cord cannot form a loop 220mm or longer at a height of less than 1600mm above floor level.

Your blind is provided with a cord guide. It is essential that the following installation instructions are adhered to:

- The cord guide may be installed lower than 1600mm above floor level if the cord is sufficiently secured or tensioned to prevent a loop of 220mm or longer being formed;
- If a cord guide is installed lower than 1600mm above floor level it must be fitted to prevent a child from being able to remove the cords.

Child Safety Installation Instructions

- Be aware that it is possible for children to strangle in window covering cords. To reduce the possibility of such an accident, all cords and chains must be kept out of reach of children, including infants. Cord cleats and cord tensioners are an effective way to implement this essential precaution.